

[Raccordo parete/copertura1]  
Sezione longitudinale

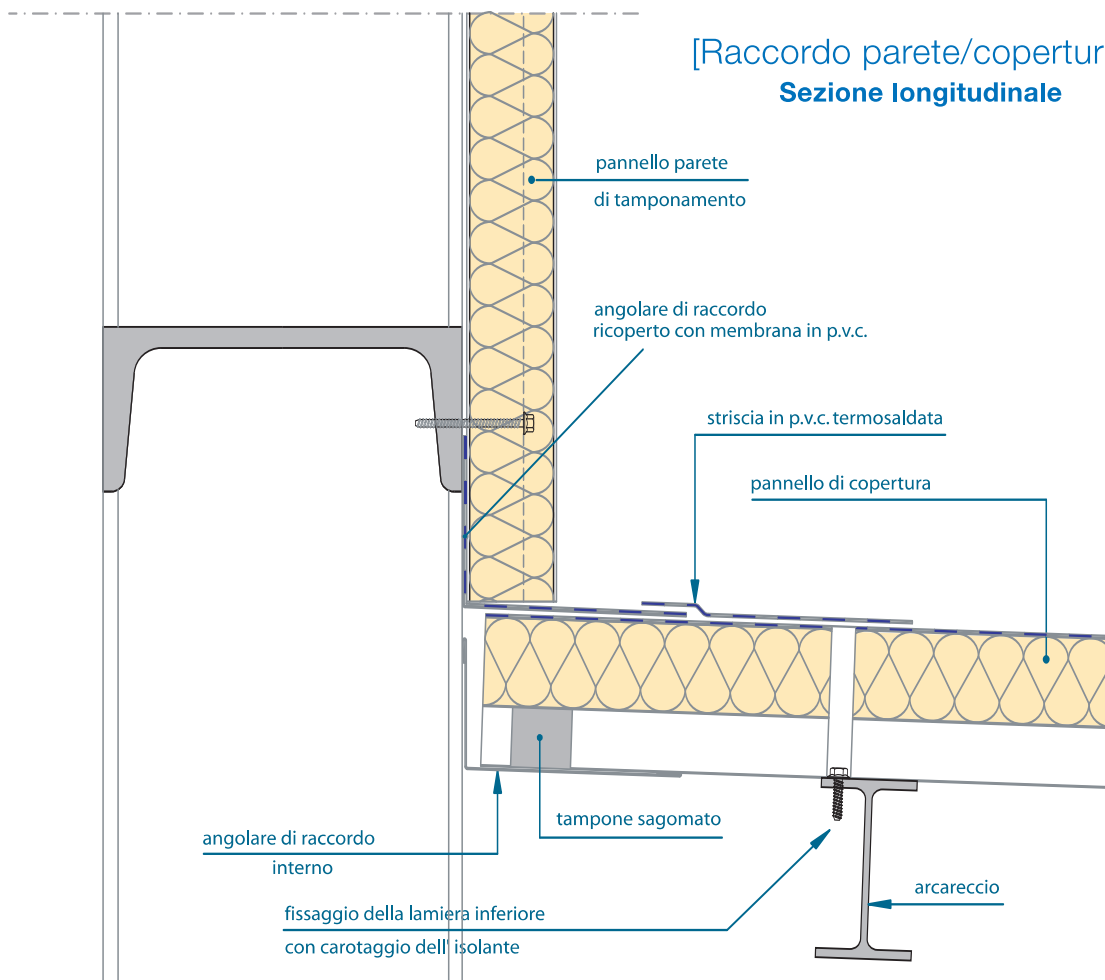

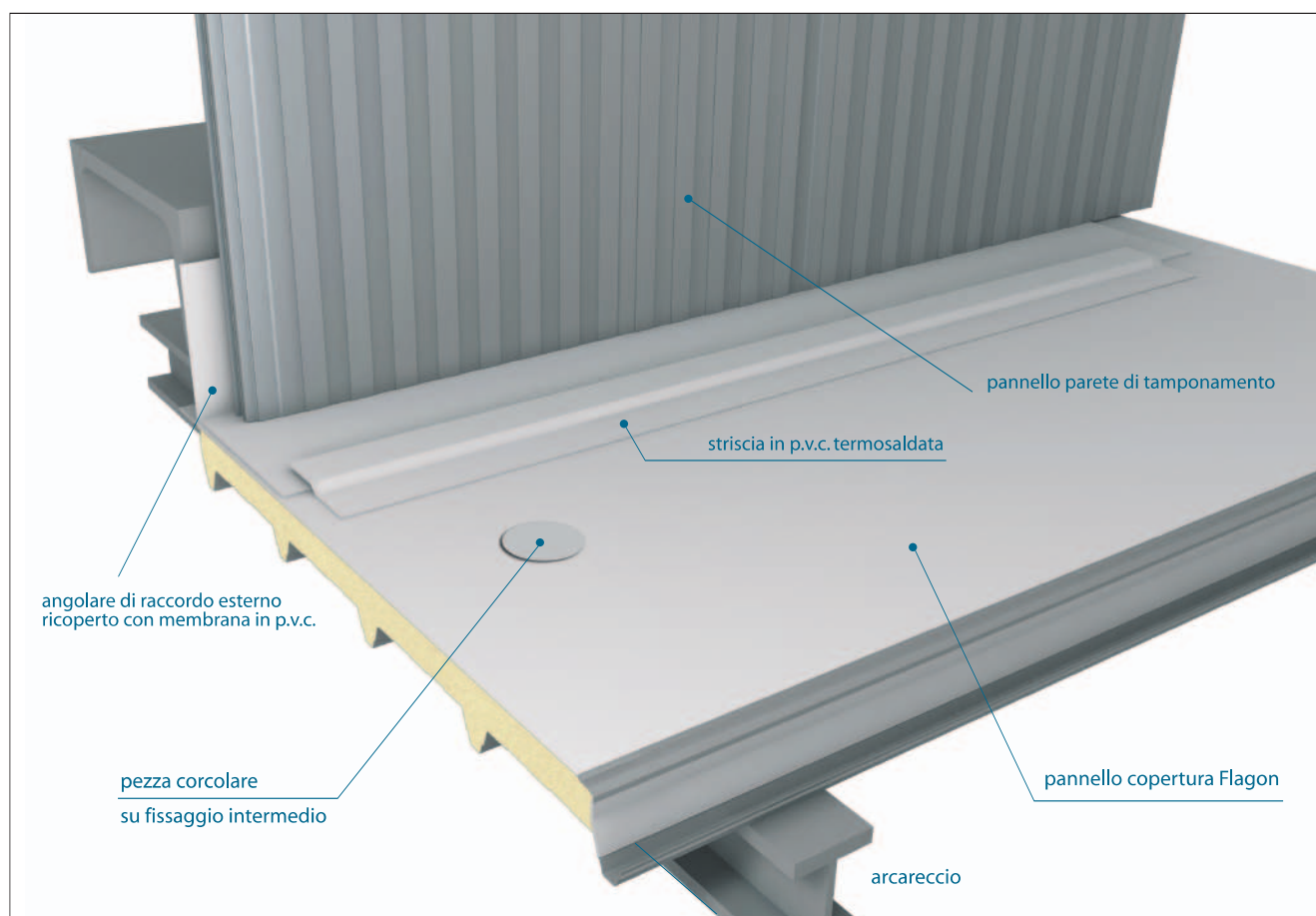

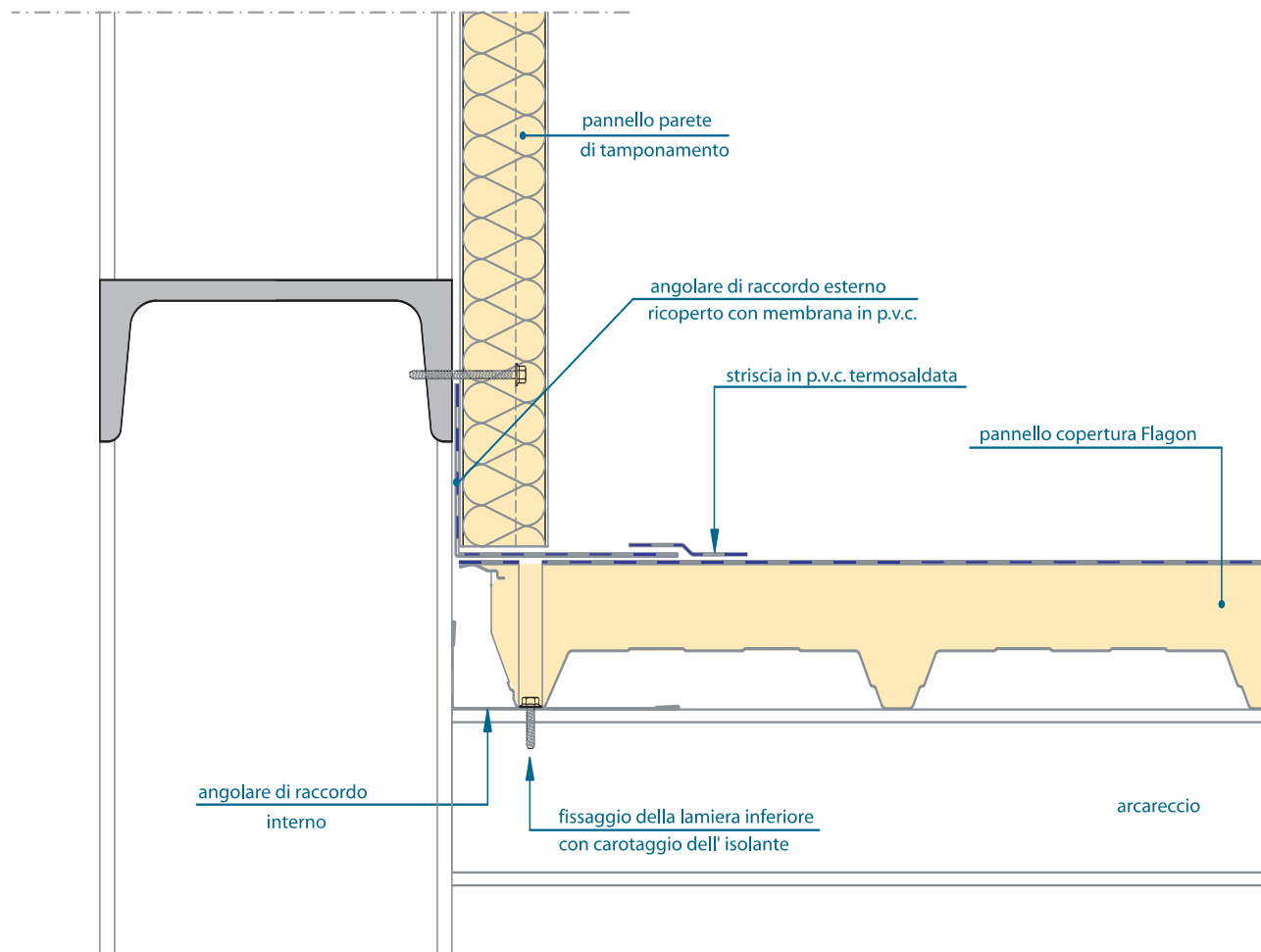
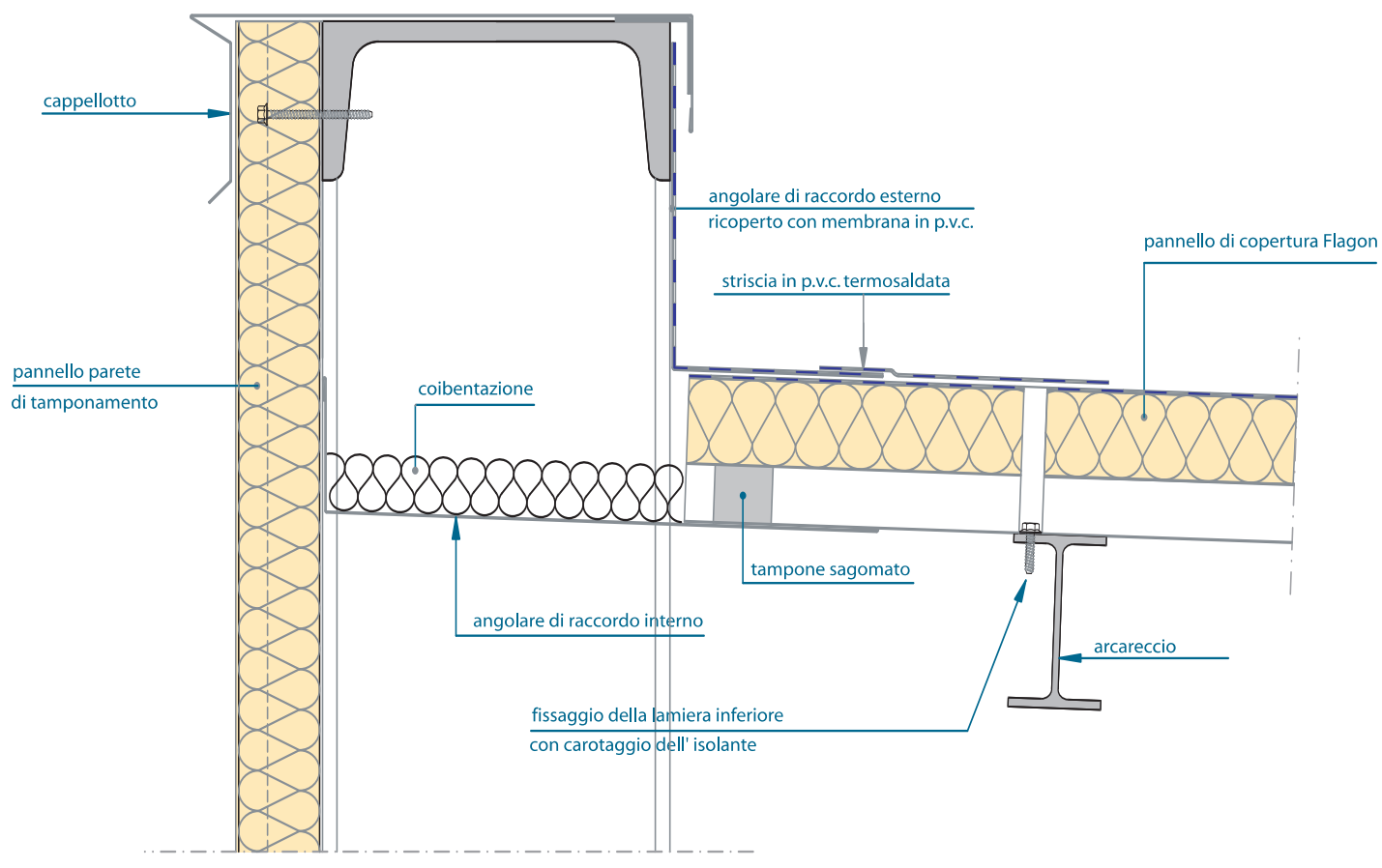

[Raccordo parete/copertura2]  
Sezione trasversale

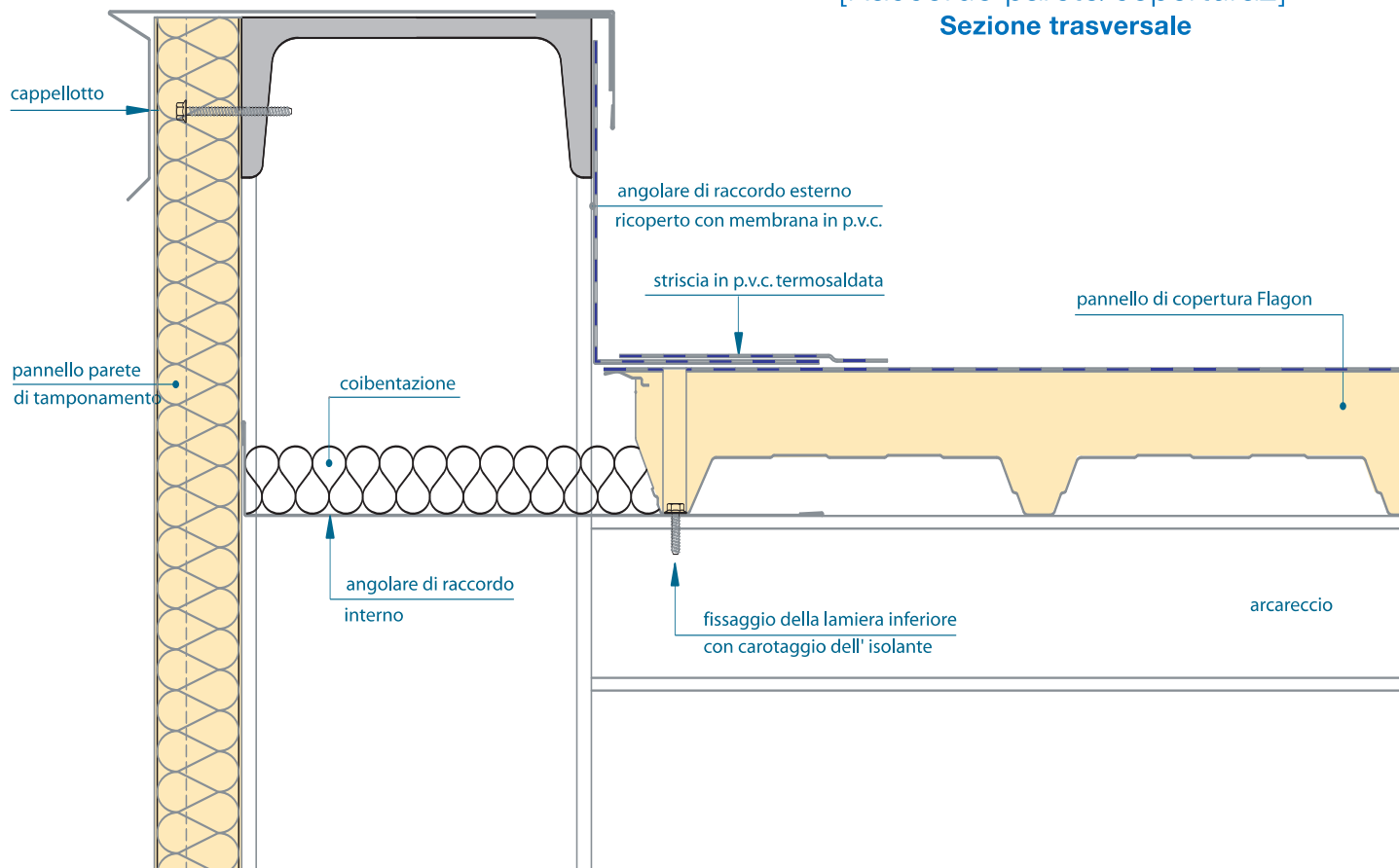

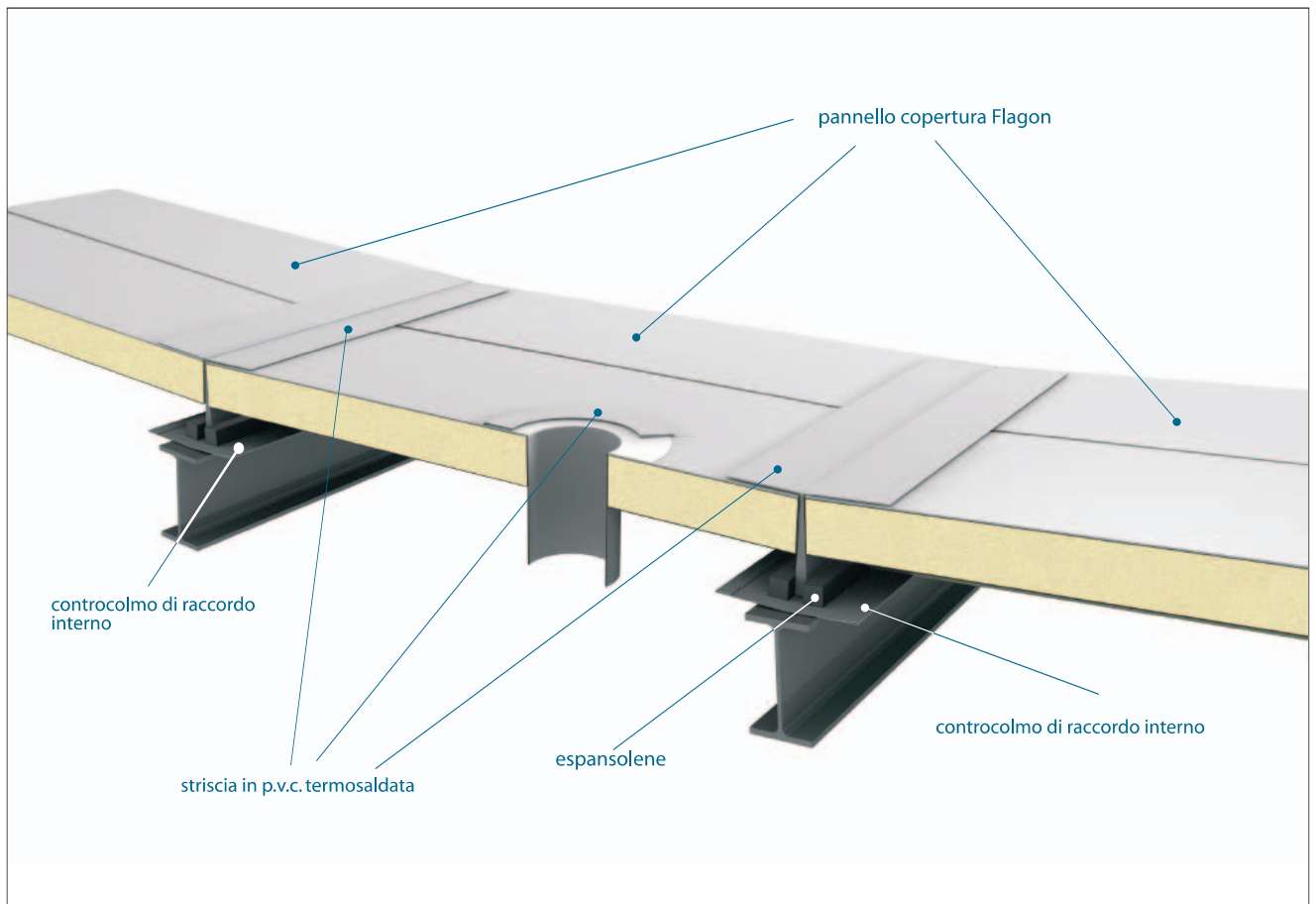
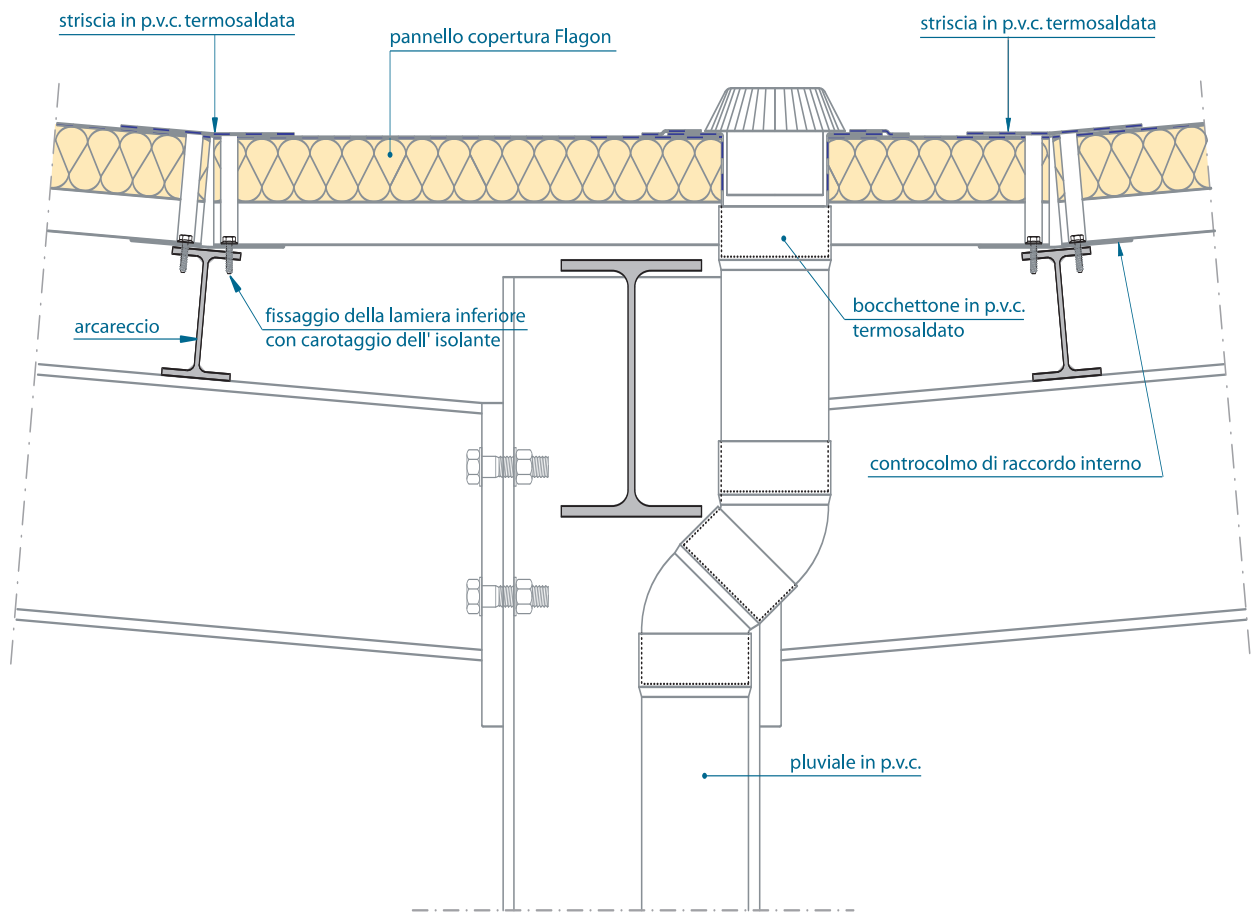

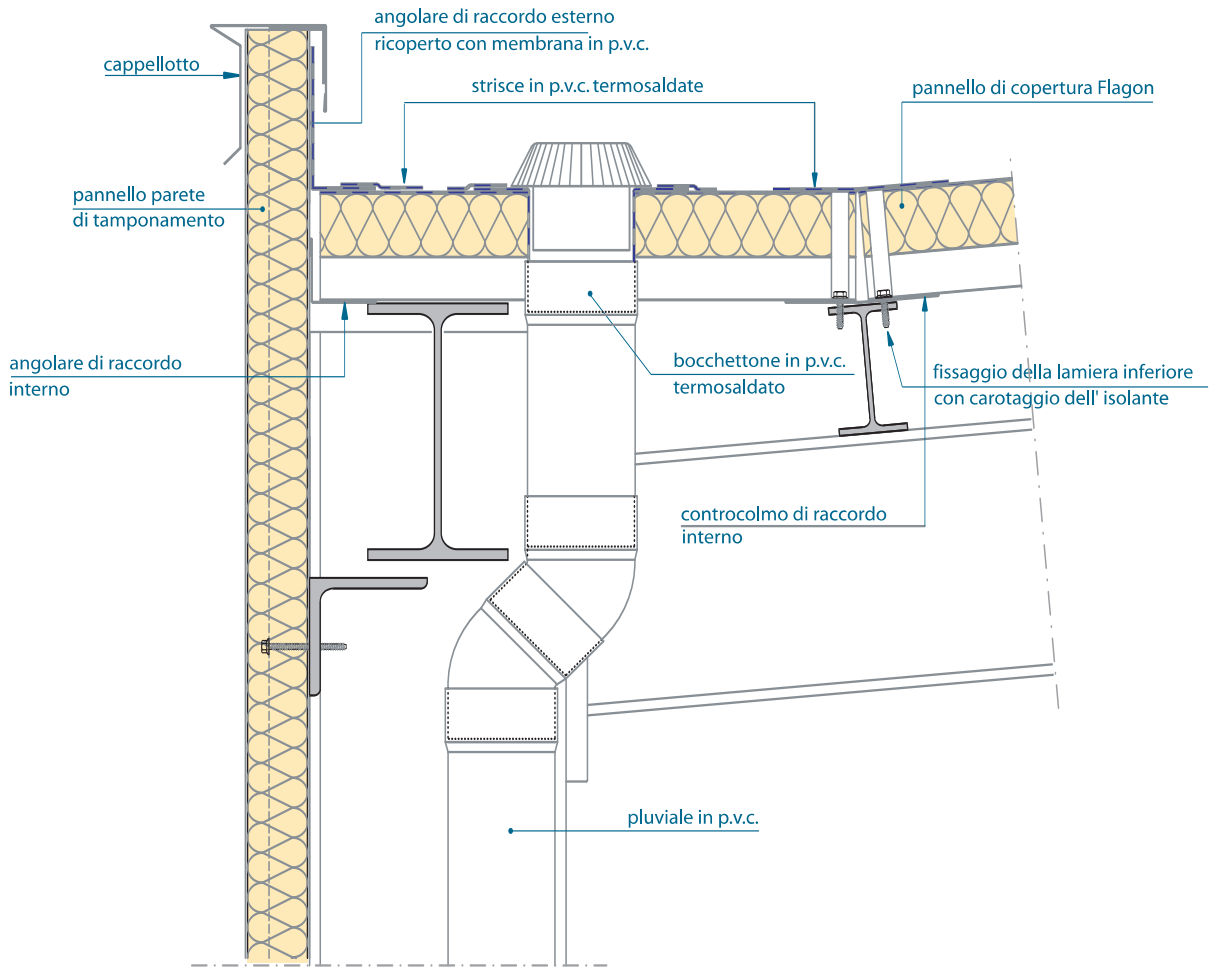

[Gronda laterale-coibentata]

